

HU Condensate canopy



Condensate canopy is designed for installation above dishwashers. Ensures a clean, hygienic and comfortable kitchen environment by removing steam produced by dishwashers. Supply air is conducted to room through the unit's front panel.

Operation

Temperature difference raises vapour into the top of the hood where it condenses on the surface of blades and flows along the side plates into condensate channel and drainage pipe. The condensation plates are removable for washing and adjusting the hood.

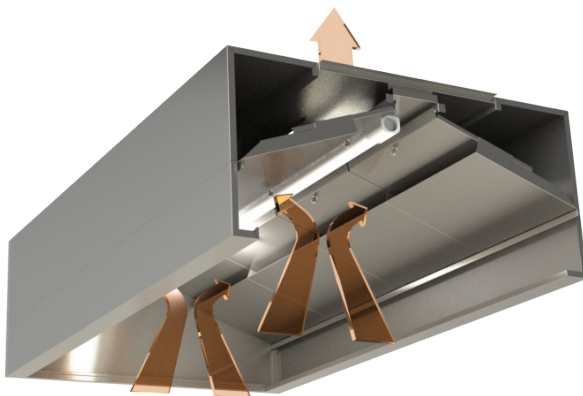

Steam trap, without supply air

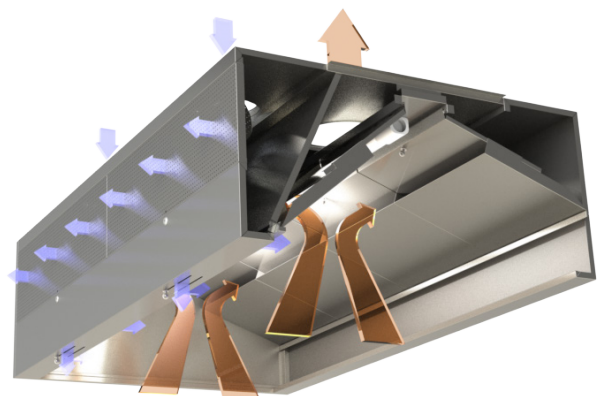

Steam trap, with supply air

Construction and Dimensions

Manufactured of stainless steel (AISI 304). Duct connections are manufactured of galvanized steel sheet and equipped with gaskets. Each hood can be provided with a surface-mounted luminary (available as accessory).

HU dimensions (mm)	
L Length	600, 700, ... , 2800, 2900
B Width	1000, 1100, ..., 1700, 1800
H Height	400, 550
S	160, 200, 250
E	200, 250, 315

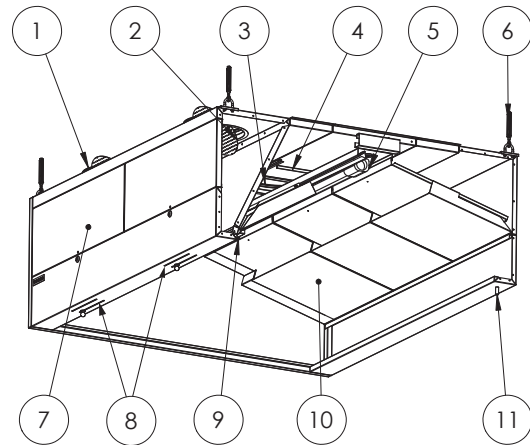

- 1 - Supply air connection
- 2 - Supply air regulating plate
- 3 - Exhaust air connection
- 4 - Adjusting plate for exhaust air
- 5 - Lighting
- 6 - Suspension points
- 7 - Front panel
- 8 - Auxiliary supply air openings
- 9 - Air flow measuring nipples
- 10 - Condensation plates (removable)
- 11 - Condensate drain connection

Exhaust air volume

Recommended exhaust air volume through one 315 mm exhaust connection is max 300 l/s when air flow speed in the duct is 3,8 m/s.

Recommended supply airflow

	SPx1+"Turbo Grip"	SPx2+"Turbo Grip"	SPx3+"Turbo Grip"
Supply air flow l/s, per linear meter of front panel	10-61 Pa 70-175 l/s	10-40 Pa 110-220 l/s	10-28 Pa 165-275 l/s

HU canopy, without supply air

L Length	600, 700, ... , 2800, 2900
B Width	1000, 1100, ..., 1800
H Height	400, 550
E1	200, 250, 315

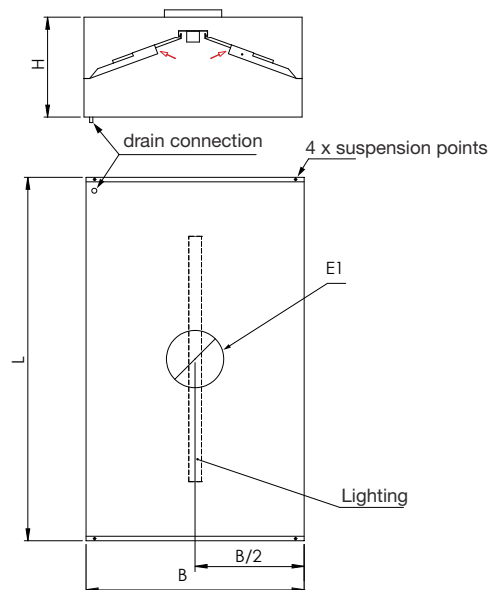

HU canopy, with supply air	
L Length	600, 700, ... , 2800, 2900
B Width	1000, 1100, ..., 1800
H Height	400, 550
S1	160, 200, 250
E1	200, 250, 315

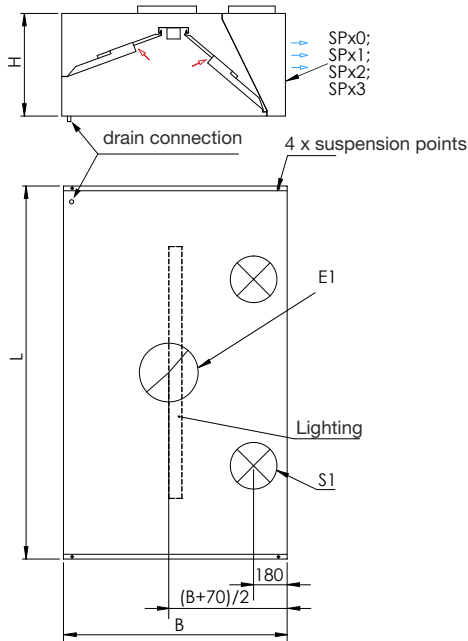

HU canopy, with supply air	
L Length	600, 700, ... , 2800, 2900
B Width	1400, 1500, ..., 1800
H Height	400, 550
S2	160, 200, 250
E1	200, 250, 315

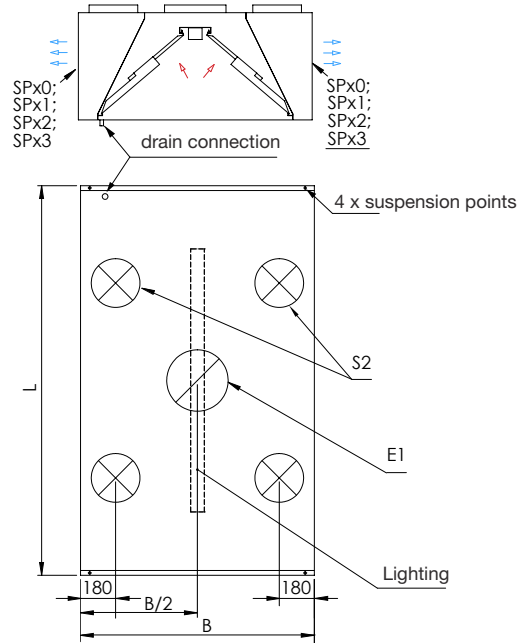

Lighting

Professional kitchen requires functioning lighting, which guarantees the employees good working conditions. ETS NORD professional kitchen canopies use next generation energy efficient LED lights, which can save up to 50% more energy compared to older fluorescent lights.

The size and number of lights is determined based on the size of the canopy, so that there is enough light output for the working space.

Luminaries:

Canopy length (mm)	Lighting length (mm)	Energy use (W)	Light color	Color temperature (K)	Color rendering index (Ra)	Flux (lm)
1000 ≤ L < 1600	LED770	20	840	4000	80	2250
1600 ≤ L < 1900	LED1370	37	840	4000	80	4900
L ≥ 1900	LED1670	53	840	4000	80	6750

Technical data

Exhaust air: HU L=1000...1400

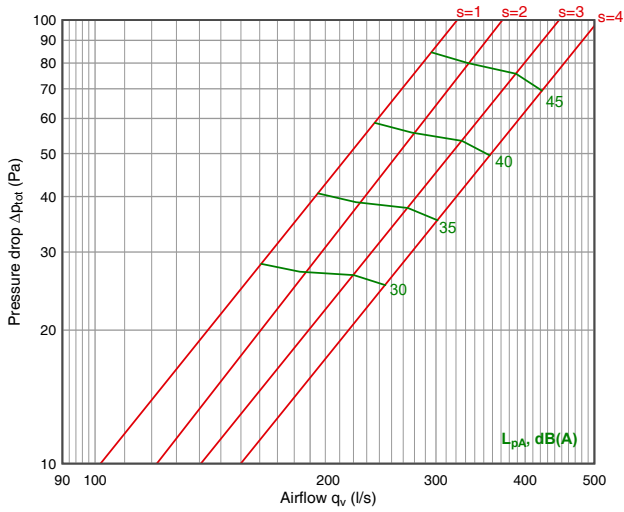

Exhaust air: HU L=1500...1900

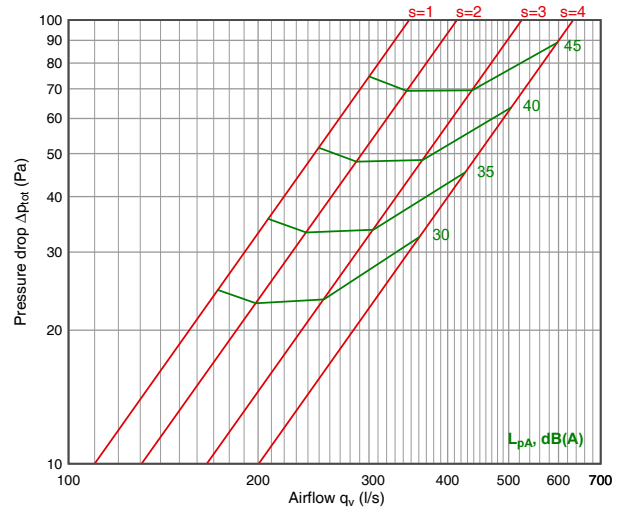

Exhaust air: HU L=2000...2400

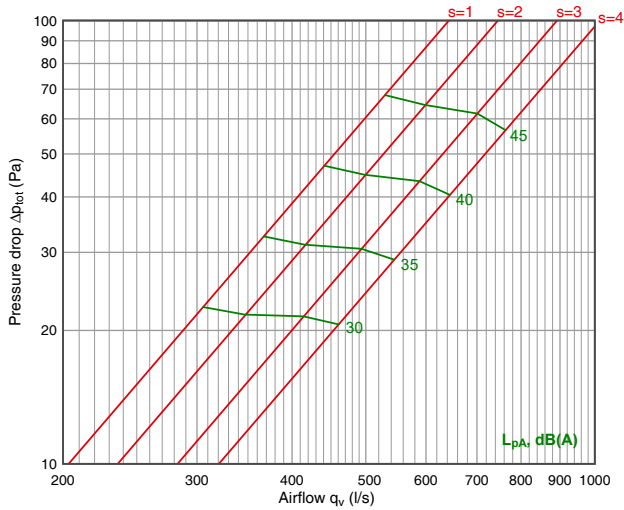

Exhaust air: HU L=2500...2900

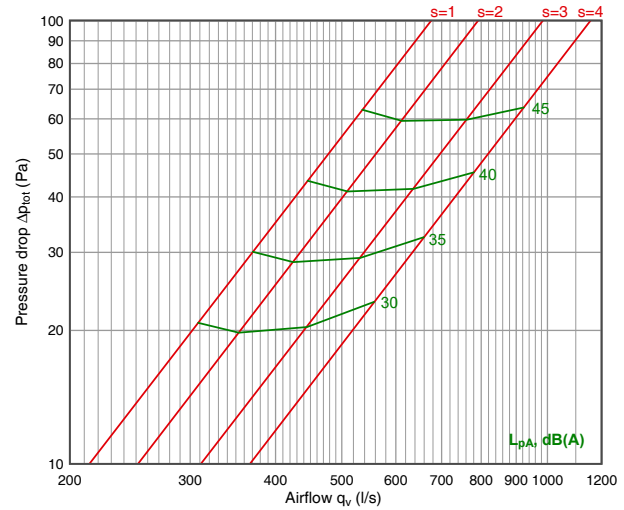

Exhaust air: HU L=3000...3400

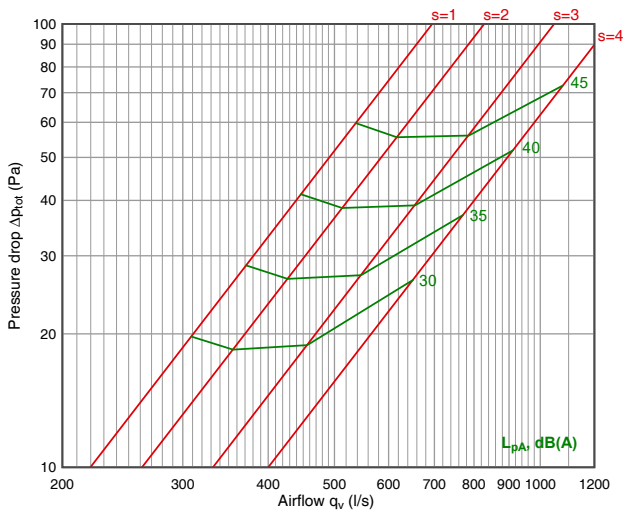

Exhaust air: HU L=3500...3900

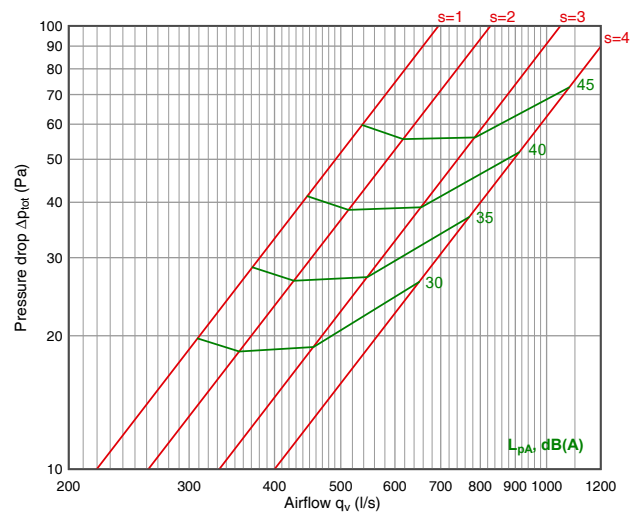

Exhaust air: HU L=4000...4400

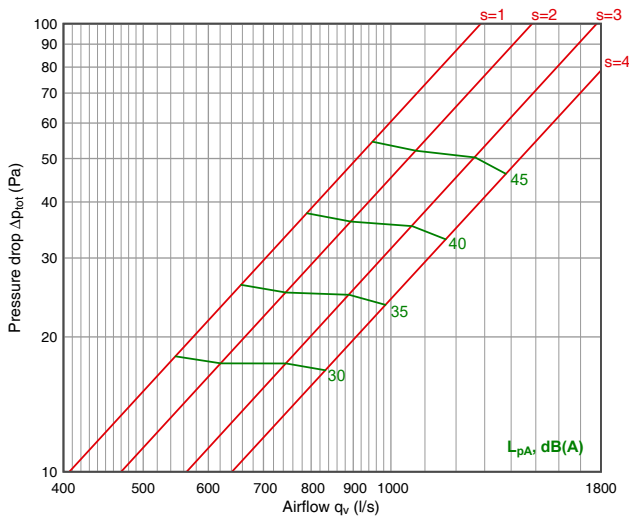

Exhaust air: HU L=4500...4900

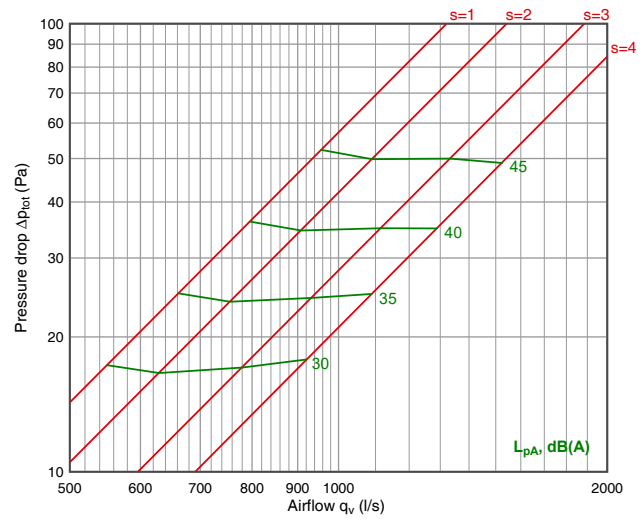

Exhaust air: HU L=5000...5400

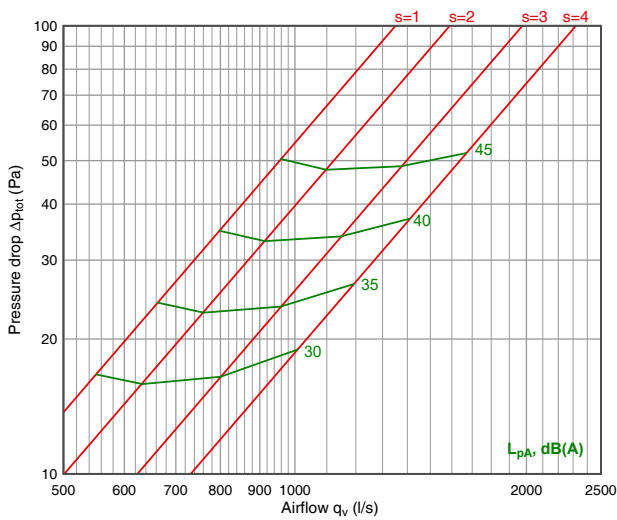

Exhaust air: HU L=5500...5900

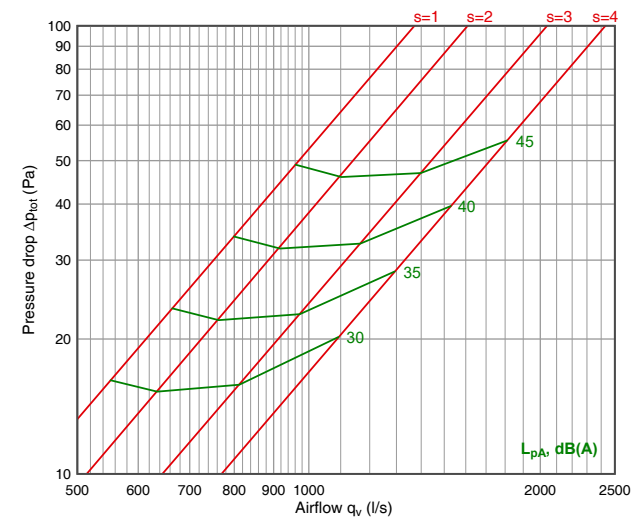

Exhaust air: HU L=6000

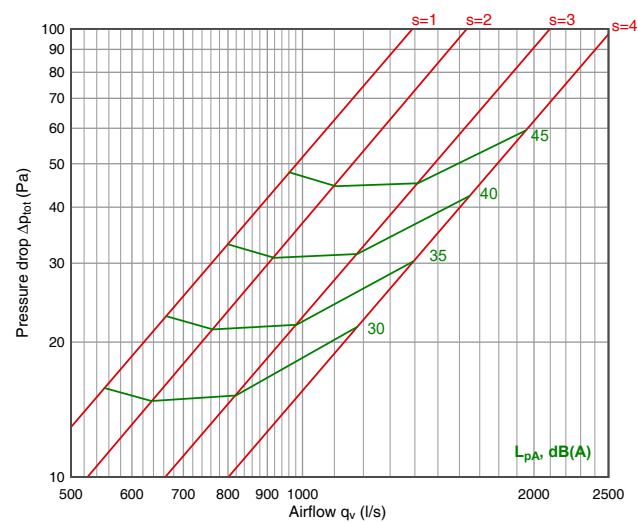

Supply air: "Turbo Grip"

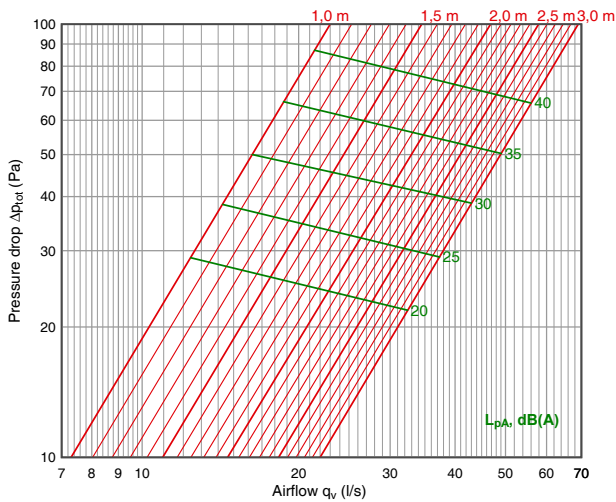

Supply air: SP1+"Turbo Grip"

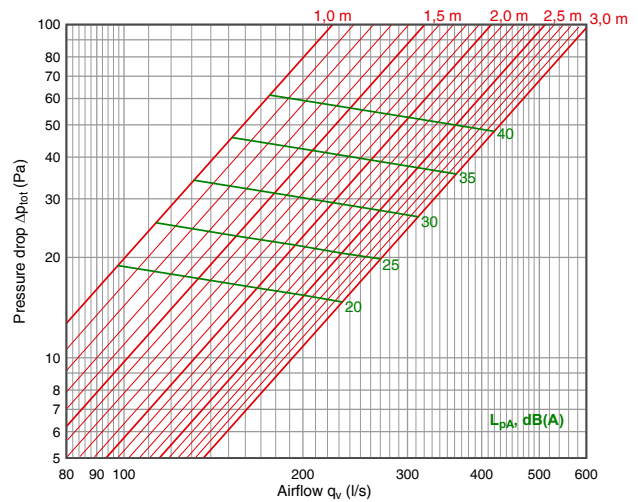

Supply air: SP2+"Turbo Grip"

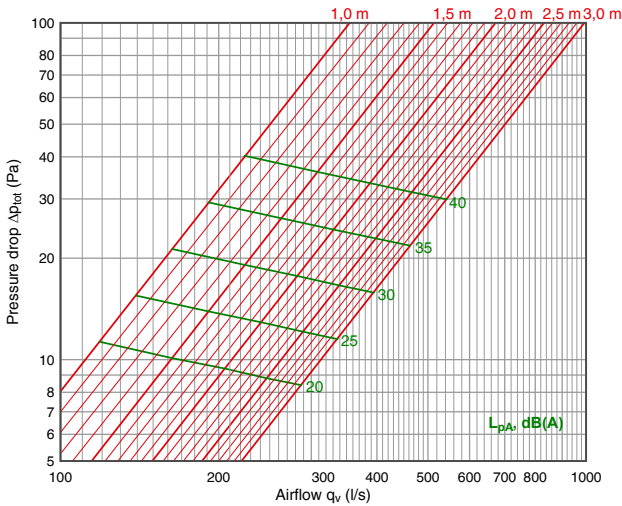

Supply air: SP3+"Turbo Grip"

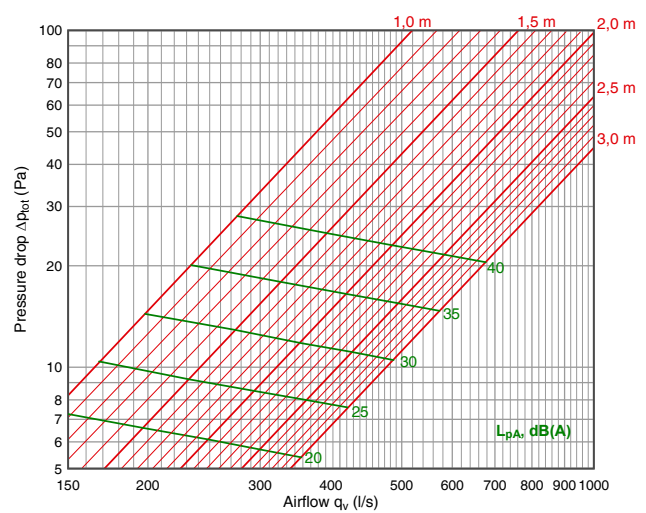

Acoustic data

$$L_w = L_{p10A} + K_{okt}$$

Exhaust air Adjusting plate position	Correction of sound level K_{okt} (dB)							
	(Hz)							
	63	125	250	500	1k	2k	4k	8k
s = 1	10	12	6	3	-4	-13	-22	-24
s = 2	11	12	6	3	-3	-10	-18	-22
s = 3	10	13	5	3	-3	-9	-16	-21
s = 4	10	13	5	3	-4	-8	-15	-20

Supply air	Correction of sound level K_{okt} (dB)							
	(Hz)							
	63	125	250	500	1000	2000	4000	8000
"Turbo Grip"	-6	-8	-5	-3	0	-1	-7	-20
SPx1 + "Turbo Grip"	-1	0	3	2	-1	-3	-11	-23
SPx2 + "Turbo Grip"	0	1	5	4	-1	-8	-20	-27
SPx3 + "Turbo Grip"	7	5	6	4	-2	-13	-21	-30
	± 4 dB	± 4 dB	± 4 dB	± 2 dB	± 2 dB	± 2 dB	± 2 dB	± 2 dB

Product marking

Marking - Dimensions - Supply air - Exhaust air - Front panel - Lighting

<p>Marking _____</p> <p>HU - Canopy</p>	<p>Dimensions _____</p> <p>L - Length B - Width H - Height</p>	<p>Supply air _____</p> <p>S1 - Supply air chamber on one side S2 - Supply air chambers on two sides Diameter of supply air connection Quantity of supply air connections</p>	<p>Exhaust air _____</p> <p>E1 - One exhaust air chamber Diameter of exhaust air connection Quantity of exhaust air connections</p>	<p>Front panel _____</p> <p>SPx0 - No Perforation, only "Turbo Grip" supply air curtain system SPx1 - Perforation pattern 1 - (per L=1000mm) 130 l/s, 40 Pa, 40 dB(A) SPx2 - Perforation pattern 2 - (per L=1000mm) 190 l/s, 37 Pa, 40 dB(A) SPx3 - Perforation pattern 3 - (per L=1000mm) 250 l/s, 25 Pa, 40 dB(A)</p>	<p>Lighting _____</p> <p>LED770 - L=769, 20W LED1370 - L=1369, 37W LED1670 - L=1669, 53W Quantity of lighting fixtures</p>
--	---	--	--	--	---

Example: **HU 2000x1000x550 - S2=200x4 - E1=315x1 - SPx1 - LED770x1**

Masking plates:

Mounted in the area between canopy and ceiling, when conduits and other components are to be concealed.